

Evaluation of the photocathode laser transverse distribution

Core + Halo Models

Chaipattana Saisa-ard
DPG Spring Meeting
12.03.16

Contents

- Introduction
- Motivation
- Transverse Laser Profile Analysis
- Results
- Conclusions & Outlook



Introduction:Photo Injector Test Facility at DESY, Zeuthen site (PITZ)

PITZ RF Photo Gun:
1½-cell copper cavity
L-band (1.3 GHz)
RF power: ~7MW peak

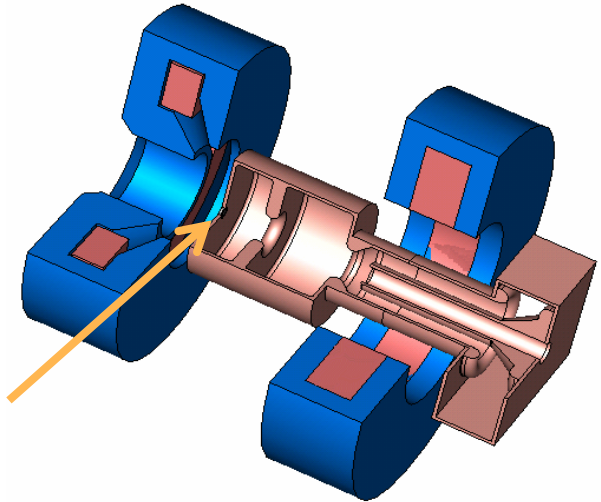

Cs₂Te cathode
QE~0.5-10%

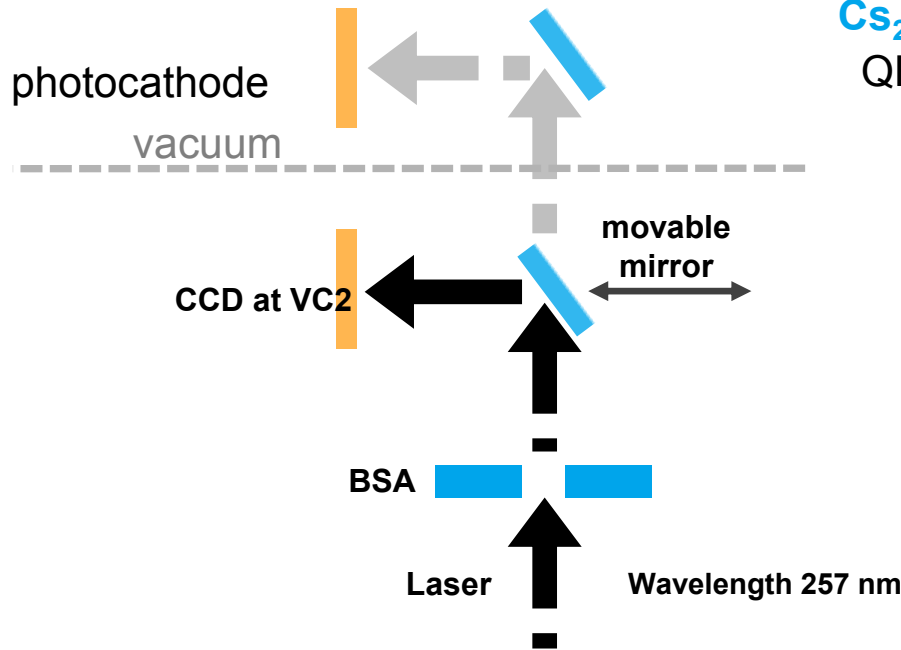

Beam Shaping Aperture (BSA) is used to control the laser beam size (diameter of the laser beam at the cathode)

In this work, the transverse laser distribution are measured using CCD camera at the image plane of the photocathode (called virtual cathode –VC2)

Schematic of transverse laser profile measurement



Motivation

- There is a problem concerning mismatch between output charge of beam dynamic simulation (ASTRA) and experiment.

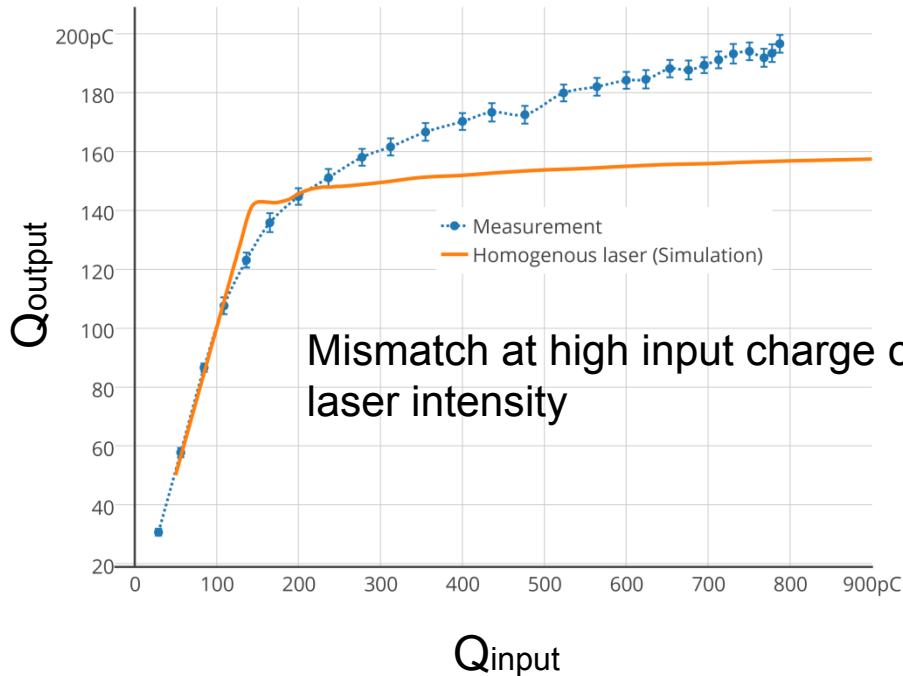

$$Q_{input} \propto QE \cdot E_{laser}$$

QE is quantum efficiency of cathode

E_{laser} is laser pulse energy

0.8 mm BSA

Halo

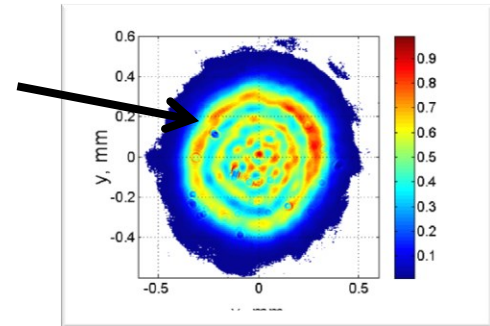

The measured transverse laser profile

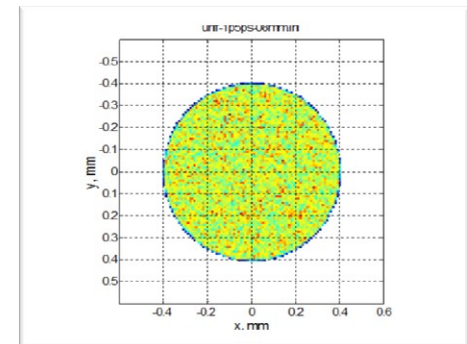

The uniform charge distribution in simulation

Core+Halo Models

- Assuming rotational symmetry (ASTRA emission model)
- We create three models named 'core+halo' to generate particle input distribution based on a measured laser transverse profile.

	Model 1.	Model 2.	Model 3.
$r < R_c$	$P(r) = A = const$	$P(r) = A$	$P(r) = A + C$
$r > R_c$	$P(r) = Ae^{-\frac{(r-R_c)^2}{2\delta^2}}$	$P(r) = Ae^{-\frac{(r^2-R_c^2)}{2\delta^2}}$	$P(r) = Ae^{-\frac{(r-R_c)^2}{2\delta^2}} + Ce^{-\frac{(r-R_c)^4}{2\delta^4}}$

Comparison between models

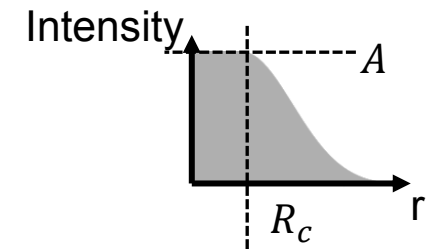
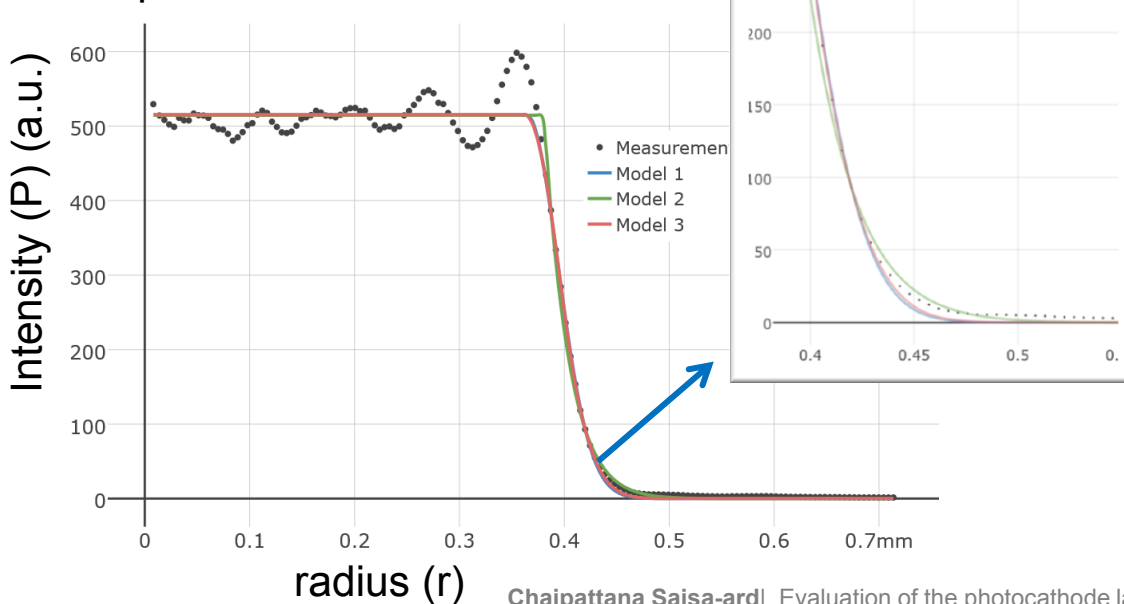

	Model 1.	Model 2.	Model 3.
A	515.2	514.6	462.5
R_c	0.363	0.380	0.362
δ	0.032	0.95	0.032
C	-	-	52.7



Procedure of Transverse Laser Profile Analysis

- Define the center of a laser beam profile by

$$\sum_{i=1}^{all} x_i \times I_i(x, y) = x_c$$

- Average profile radially, $P_{meas}(r) = \langle P_\alpha \rangle$

- The difference between the laser beam profile and a

$$\text{model, } \Delta(A, R_c, \delta, (C)) = \frac{\int_0^{R_c} |I_{meas} - I_{model}| r dr}{\int_0^{\infty} I_{meas} r dr} \rightarrow \text{minimized}$$

- Core-halo qualities: ratio of halo to core, modulation, azimuthal variation of profile.
- There are about 100 profiles within 0.3-2.0 mm BSA in 2015. All of them are analyzed with MATLAB

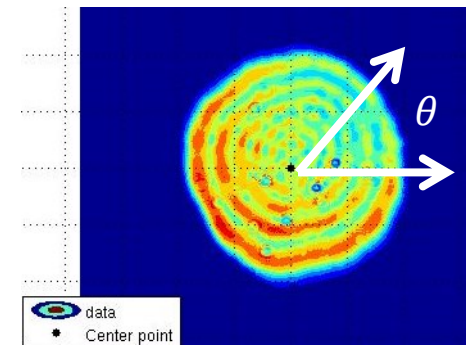

Results: Halo to Core Ratio

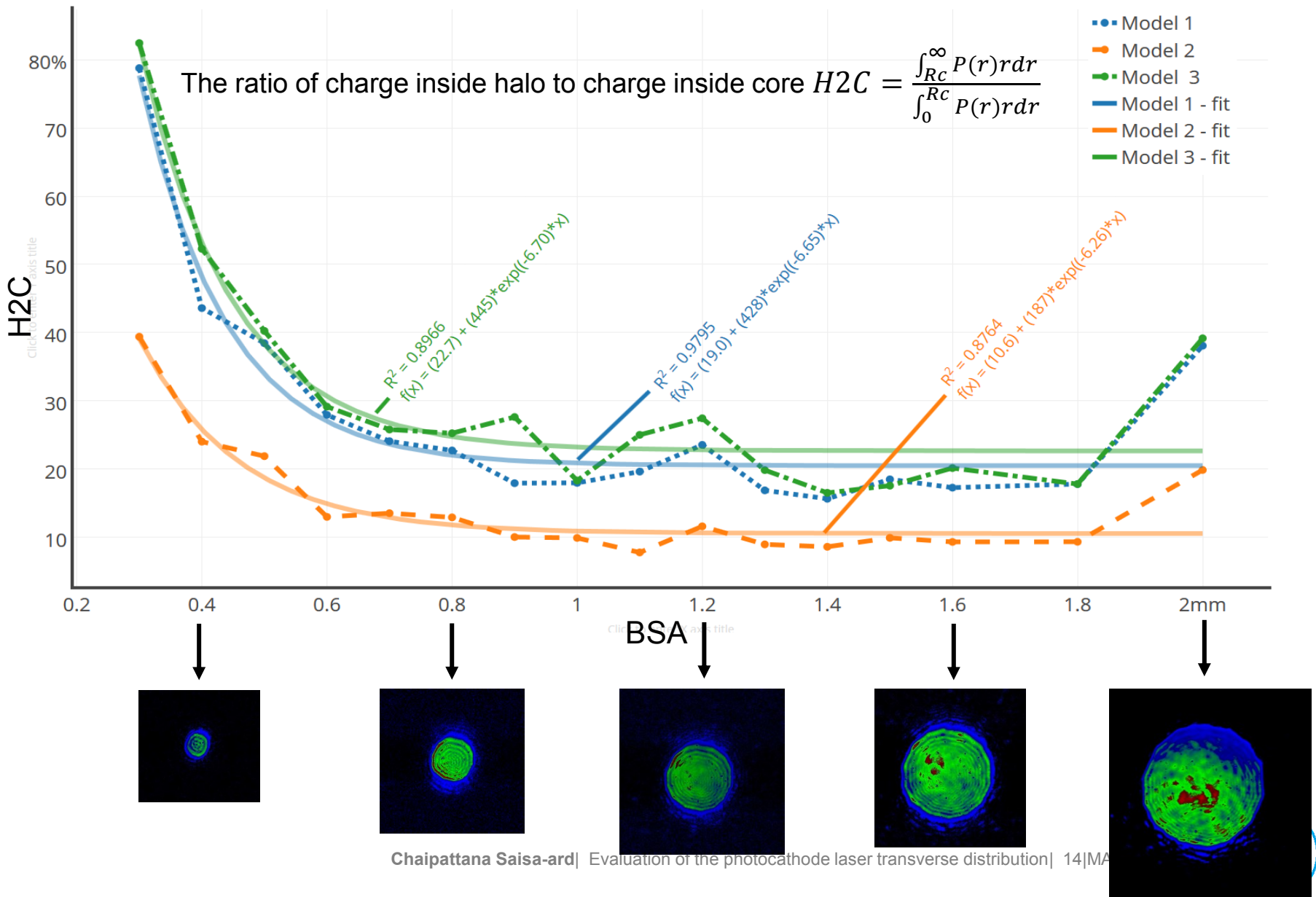

Results: Core Modulation (mod) Quality

$$\text{mod} = \frac{\int_0^{R_c} |P_{meas} - P_{model}| r dr}{\int_0^{R_c} P_{meas} r dr}$$

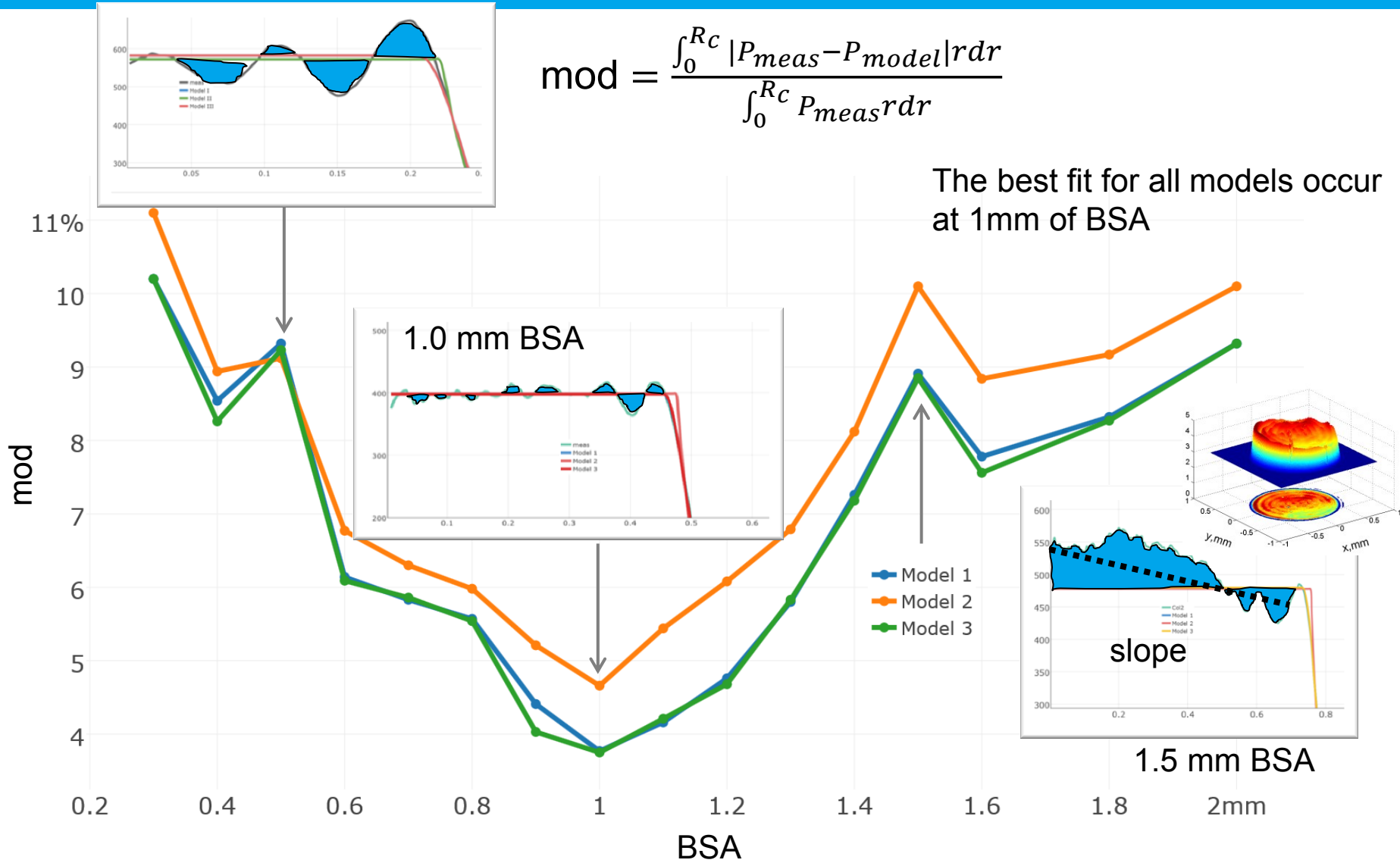

Results: Comparison of Charge Emission between Measurement and Simulations with/without Halo

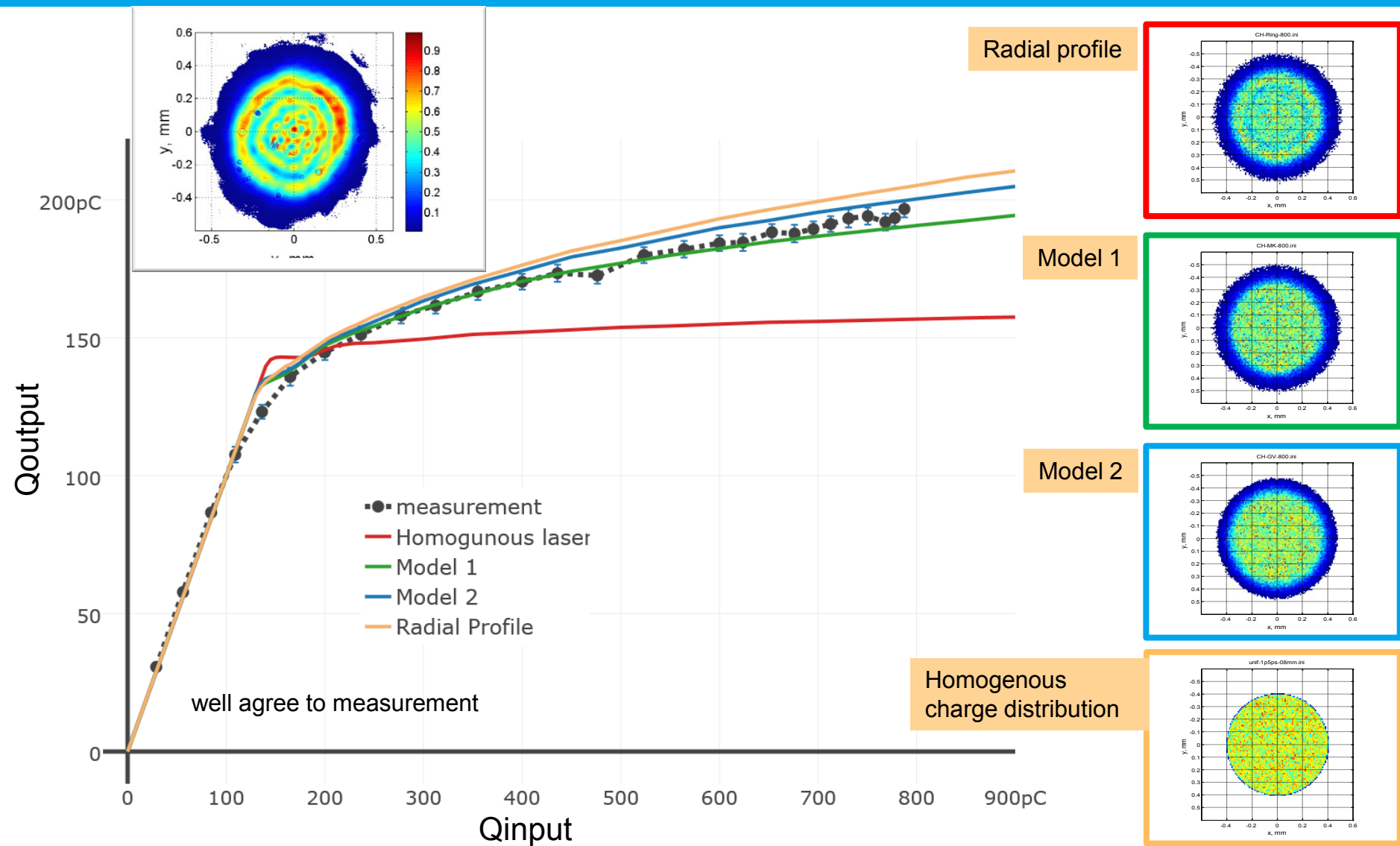

Conclusions & Outlook

Conclusions

- Figure of merit was introduced for qualitative evaluation of the laser profile by implemented core+halo models.
- For smaller BSA, the core modulation is occurred by diffraction while larger BSA it is occurred by non homogeneous core.
- The growth of BSA decreases the halo effect
 - $H2C \propto \exp(-6.65*BSA)$ for model 1
 - $H2C \propto \exp(-6.26*BSA)$ for model 2
 - $H2C \propto \exp(-6.70*BSA)$ for model 3
- Using core+halo models in beam dynamic simulation, the output charge results agree well to measurement.

Outlook

- The azimuthal homogeneity to be considered for qualitative evaluation.



Thank you for attention

